

Rev	Redrower	Date	Modification
A	Sugiyama	2020.5.26	初版

参考図(アーム角度=90° の場合)

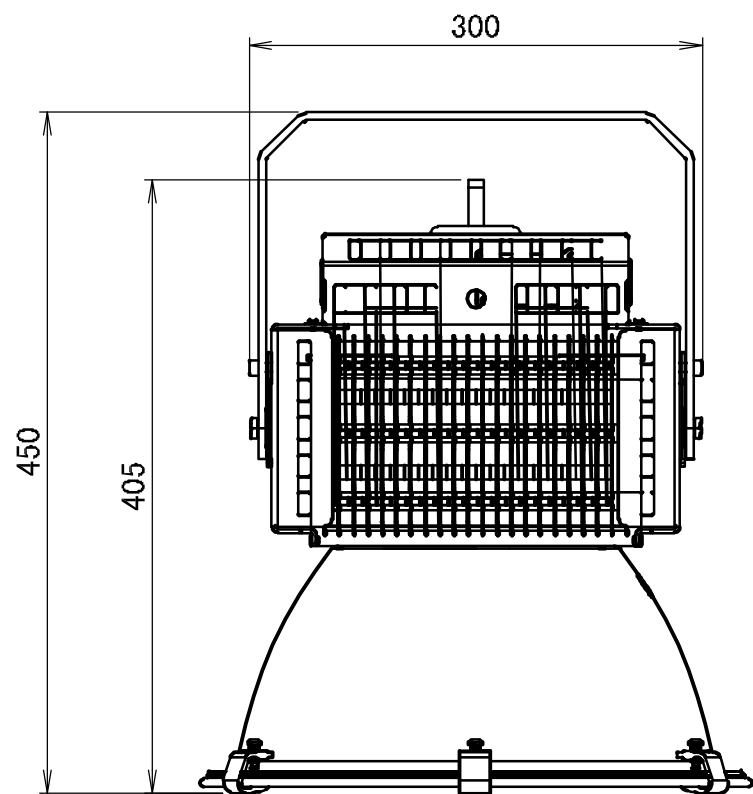
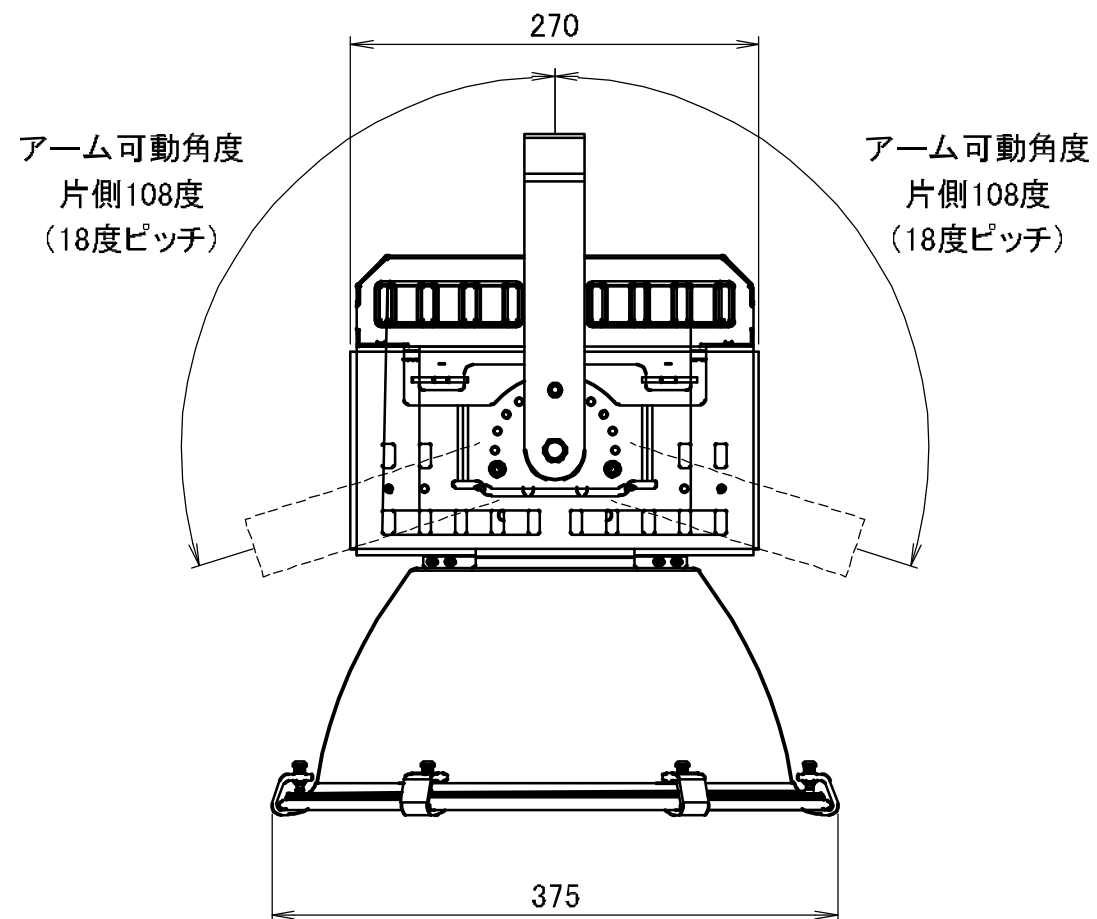
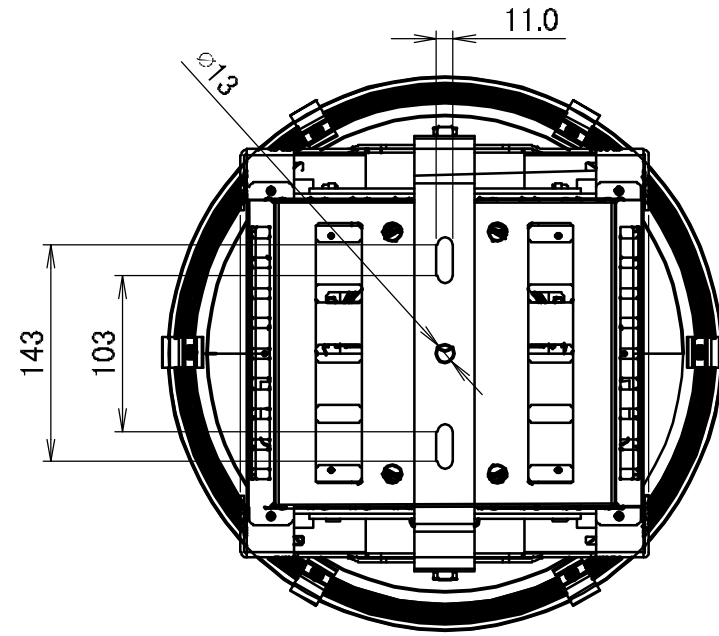
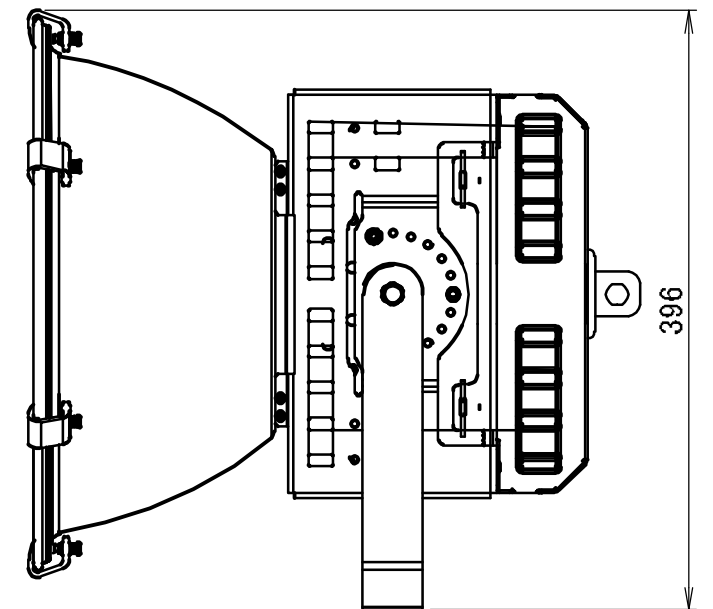

Presented by		株式会社ダイク		
Drowed by	Sugiyama	2020.5.26	Scale	1 / 5 trigonometry
Approbed by	Mitaki	2020.5.26	Design Name OH-135 外形図	
Customer	技術資料		Design Num	Revision
Date	2020.5.26		DA3-00021	A